

*High Power Solid-State LED Light Source*

# LUSTRON X2<sup>NES</sup>

## Introduction

For a brighter solid-state light source, **LUSTRON X2<sup>NES</sup>** is an energy-efficient building block generating enough light outputs suitable for most applications in lighting field. **LUSTRON X2<sup>NES</sup>** offers the best solid-state light source and you might realize your modern ideas of lightings.

**LUSTRON X2<sup>NES</sup>** provides the best possible performance with lifetime longer than 30,000 hours\*. With a nominal correlated color temperature of 2500~3250K for Warm White , 3250~4750K for Neutral White, and 4750~10000K for Cool White, similar to conventional indoor light source, **LUSTRON X2<sup>NES</sup>** is particularly designed for architects and commercial lighting designers.

\*Note1: To optimize product performance and lifetime, constant DC at indicated forward current and T<sub>b</sub> less than 50°C should be applied.

**LUSTRON X2<sup>NES</sup>**

---

---

# LUSTROUS®

GREEN TECHNOLOGY OF LIGHTINGS

## LUSTRON X2<sup>NES</sup> Part Number Matrix

Table.1

Color	P/N
Warm White	NES110CLC0B
Neutral White	NES110MWC0B
Cool White	NES110NWC0B

## LUSTRON X2<sup>NES</sup> Material

Chip Material	GaN Base
---------------	----------

## LUSTRON X2<sup>NES</sup> Chips Array

9 Chips Array
---------------

---

# LUSTRON X2<sup>NES</sup>

**Mechanical Dimensions**

**LUSTRON X2<sup>NES</sup>**

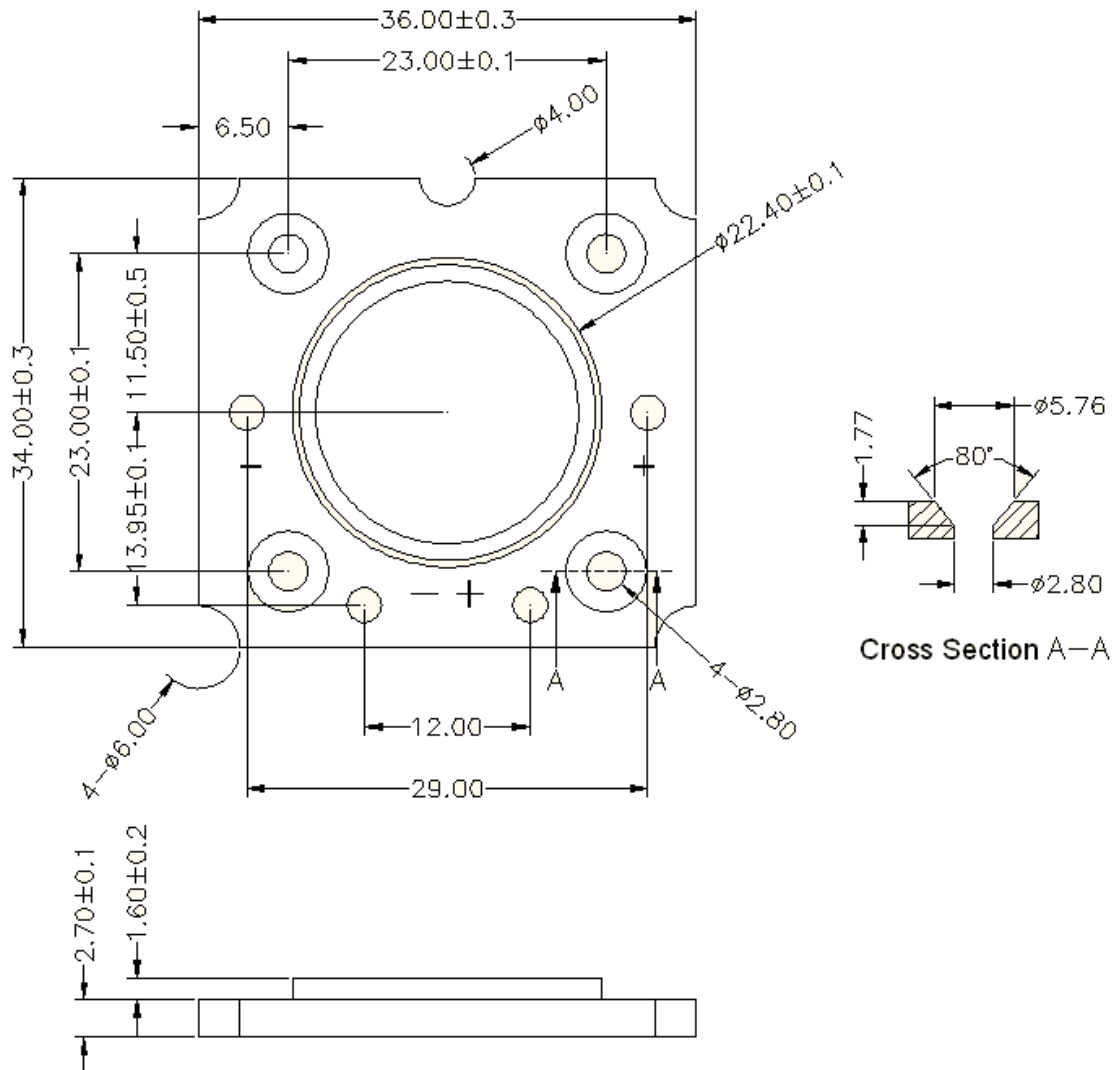

Note1: Drawing not to scale. All dimensions are in millimeters.

---

**LUSTROUS**<sup>®</sup>

GREEN TECHNOLOGY OF LIGHTINGS

### Recommended installation screw pitch

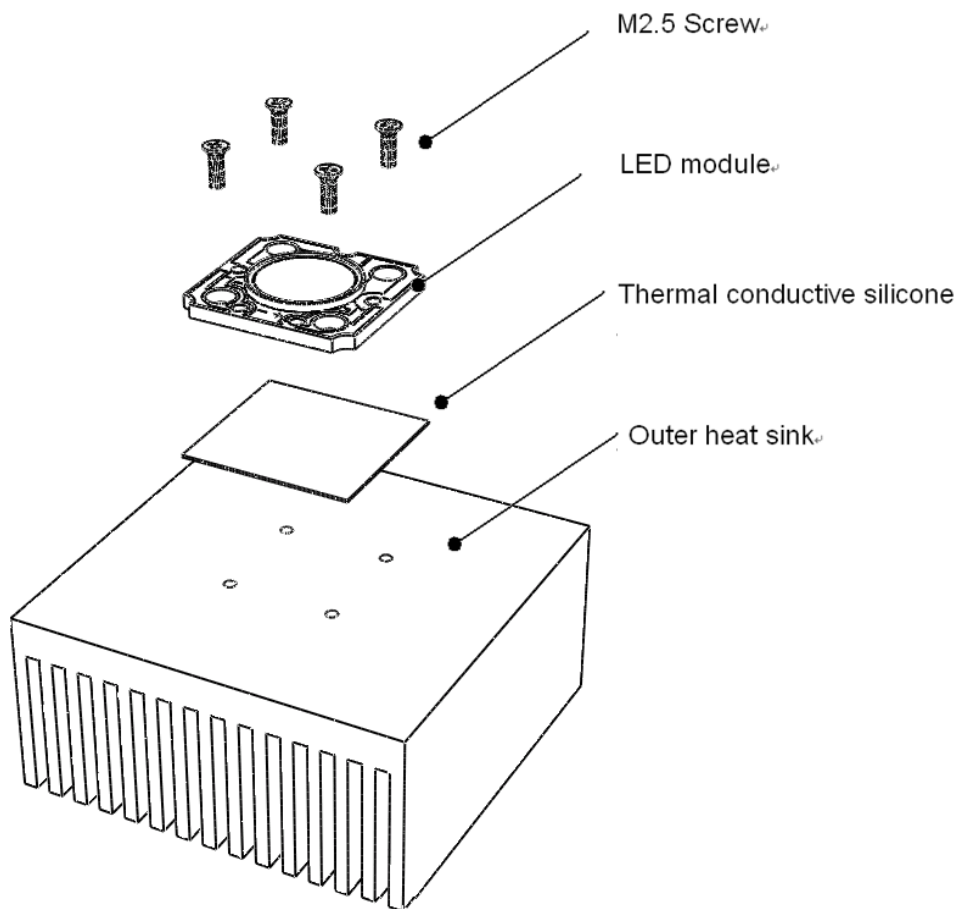

#### Warning:

**Do not** touch the lighting area during handling and assembling.

---

**LUSTRON X2**<sup>NES</sup>

# LUSTROUS<sup>®</sup>

GREEN TECHNOLOGY OF LIGHTINGS

## Flux Characteristics at 1050mA, Junction Temperature T<sub>j</sub> = 25<sup>o</sup>C

Table.2

Color	Minimum Luminous Flux (lm)	Typical Luminous Flux (lm)
Warm White (2700K)	450 lm	500 lm
Neutral White (4000K)	500 lm	580 lm
Cool White (5700K)	580 lm	660 lm

Note1: Luminous flux is measured in total power with tolerable errors of 10%. Minimum luminous flux performance guaranteed within published operating conditions.

Note2: Higher luminous flux will become available in the near future.

## Optical Characteristics

Table.3

Color	λ <sub>d</sub> ( nm ) or CCT( K )			Viewing Angle (degrees)	CRI
	Min	Typ	Max		
Warm White	2500K	2700K	3250K	~120	75
Neutral White	3250K	4000K	4750K		
Cool White	4750K	6000K	10000K		

Note1: CRI value is measured with tolerable errors of 10%.

LUSTRON X2<sup>NES</sup>

# LUSTROUS<sup>®</sup>

GREEN TECHNOLOGY OF LIGHTINGS

## Electrical Characteristics

Table.4

Color	Forward Voltage (V) for 1050 mA forward current		
	Min	Typ	Max
Warm White			
Neutral White	9.4	10.5	11.5
Cool White			

Note1: Lustrous Technology allows a tolerance of each LED for voltage measurements.

Note2: Measurements are taken under each nominal forward current.

## Absolute Maximum Ratings

Table.5

Parameters	For 1050mA forward current	
	Warm White/ Neutral White/ Cool White	
Advised DC Forward Current (mA)	1050	
Max. DC Forward Current (mA)	1200	
LED Junction Temperature ( $^{\circ}C$ )	< 125	
ESD Sensitivity	+/- 4kV (HBM)	
Thermal Resistance ( $^{\circ}C/W$ )	~2.5	
Operating Temperature ( $^{\circ}C$ )	-25 ~ +85	
Storage Temperature ( $^{\circ}C$ )	-40 ~ +100	
Soldering Temperature ( $^{\circ}C$ )	260 (duration should be less than 5 seconds)	

Note1: Proper current operating must be observed to maintain junction temperature below the maximum.

# LUSTRON X2<sup>NES</sup>

**LUSTROUS**<sup>®</sup>  
GREEN TECHNOLOGY OF LIGHTINGS

**Relative Intensity vs. Current (T<sub>j</sub> = 25°C)**

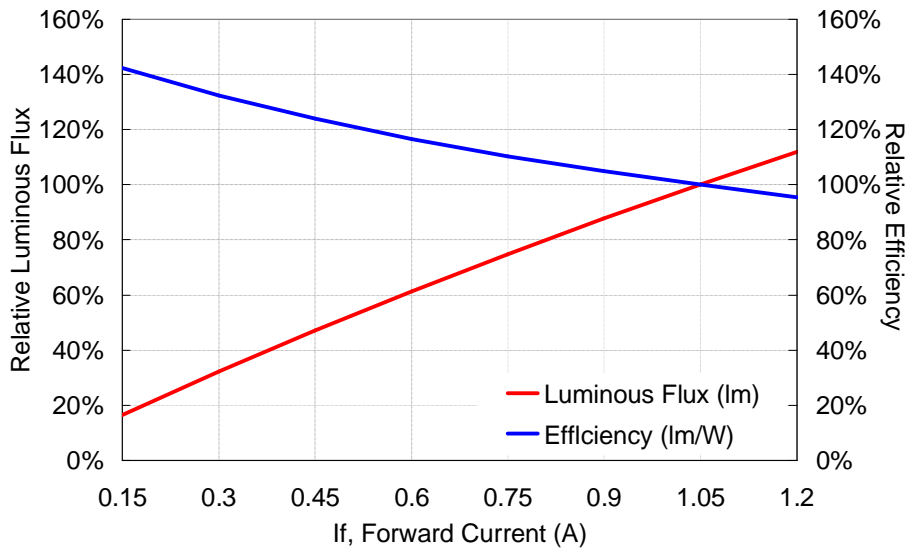

**Photometric Output vs. Board Temperature (If = 1050mA)**

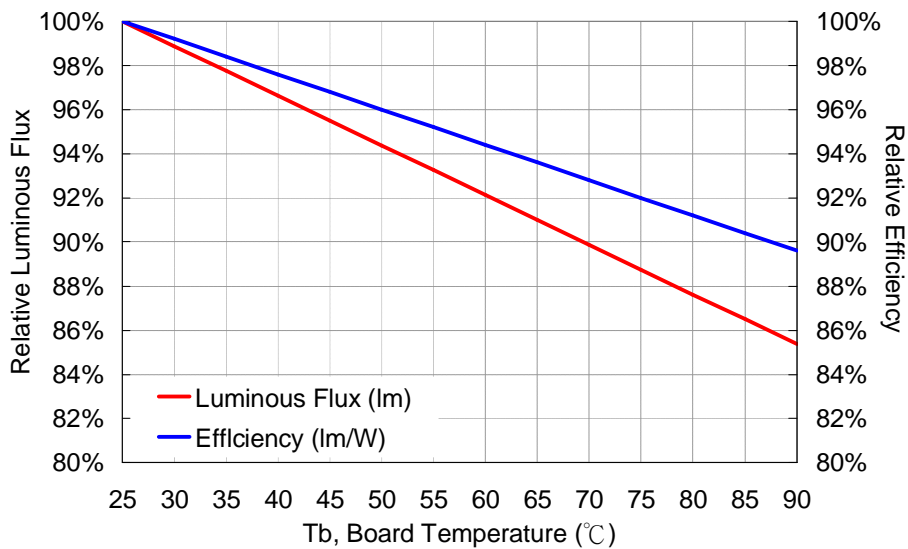

**LUSTRON X2**<sup>NES</sup>

**Relative Spectral Power**  
**Warm White (2700K)**

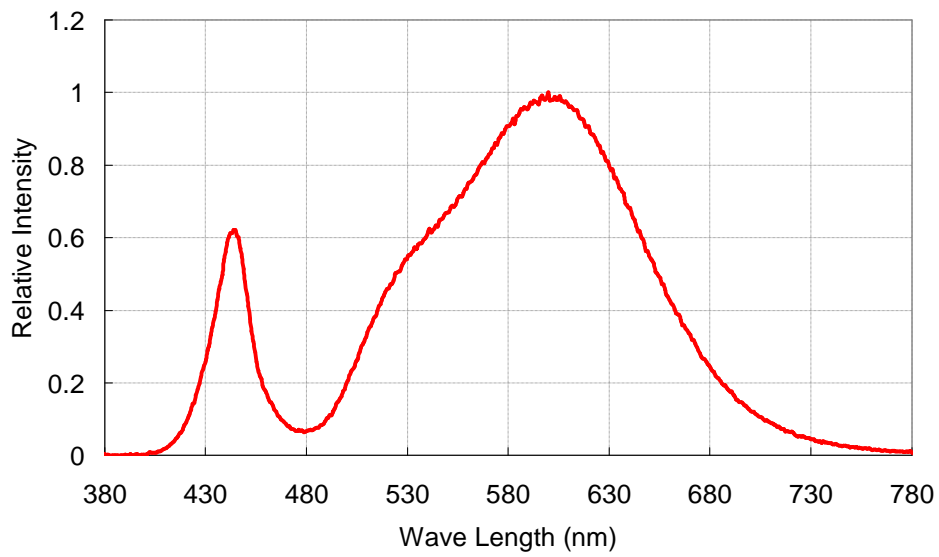

**Neutral White (4000K)**

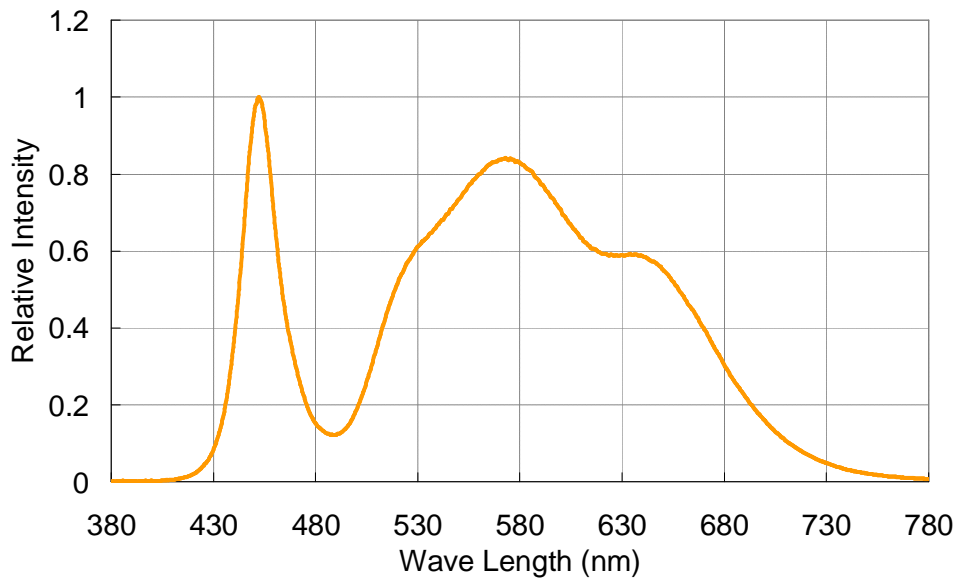

---

**LUSTROUS**<sup>®</sup>  
*GREEN TECHNOLOGY OF LIGHTINGS*

**Cool White (5700K)**

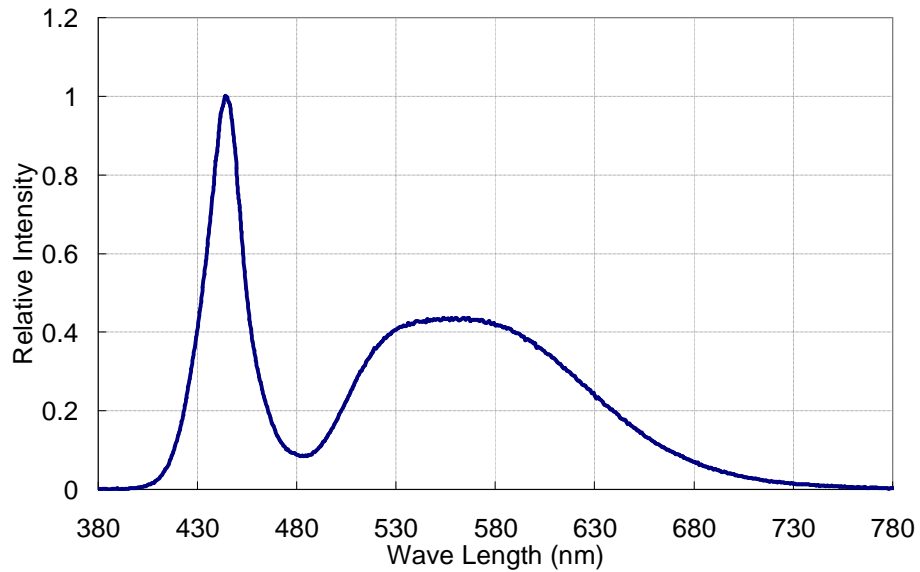

**Forward Voltage vs. Current (T<sub>j</sub> = 25°C)**

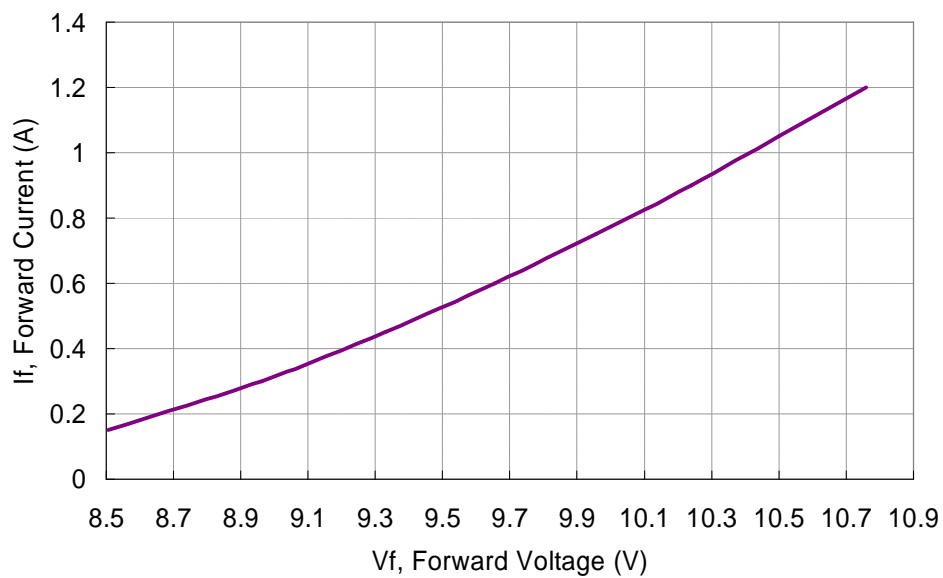

**LUSTRON X2**<sup>NES</sup>

**Operating Curve ( Max. permissible forward current )**

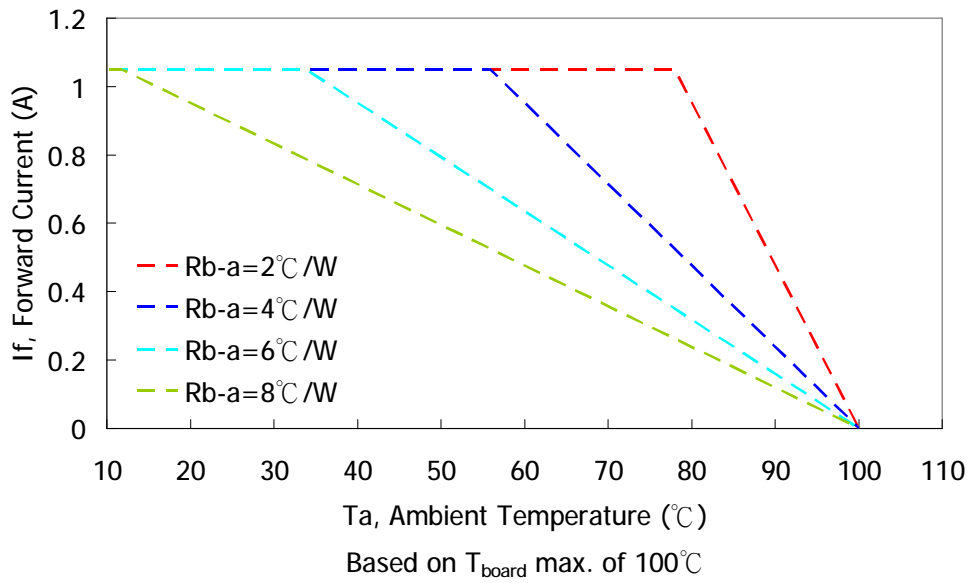

**Board Temperature vs. Forward Voltage ( If=1050mA )**

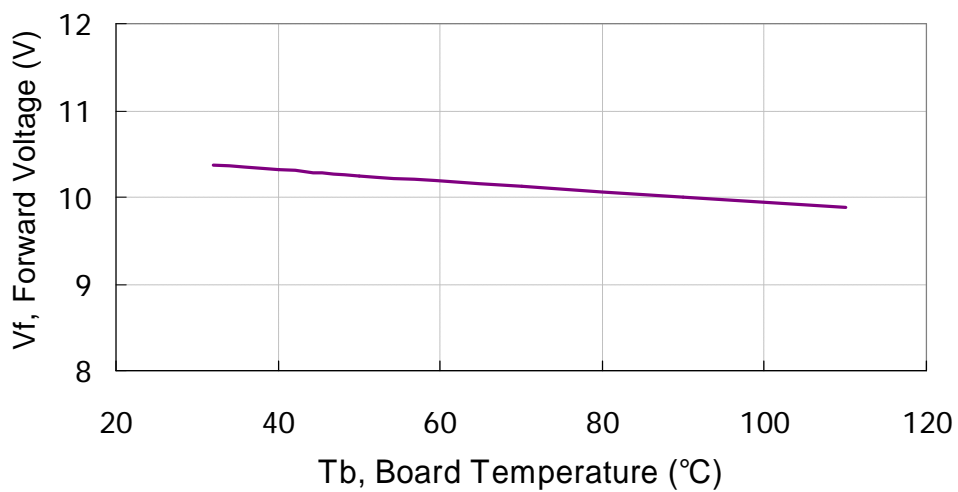

---

# LUSTROUS<sup>®</sup>

GREEN TECHNOLOGY OF LIGHTINGS

Typical Angular Beam Profile,  $T_j=25^{\circ}C^*$

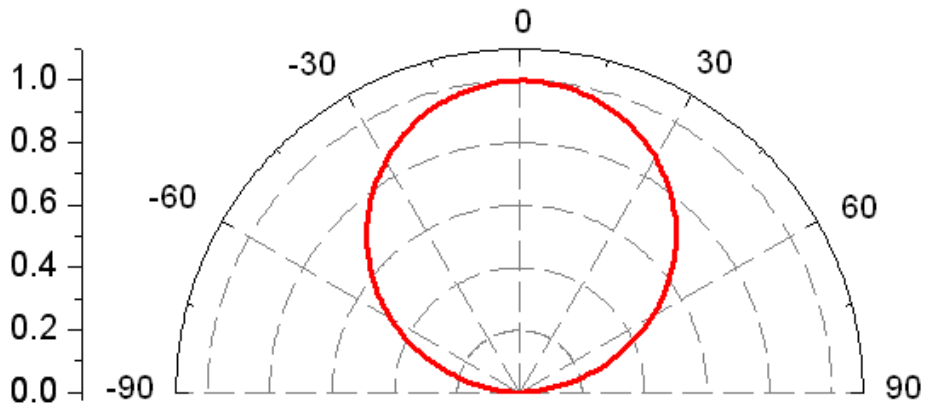

View Angle: 120 degree

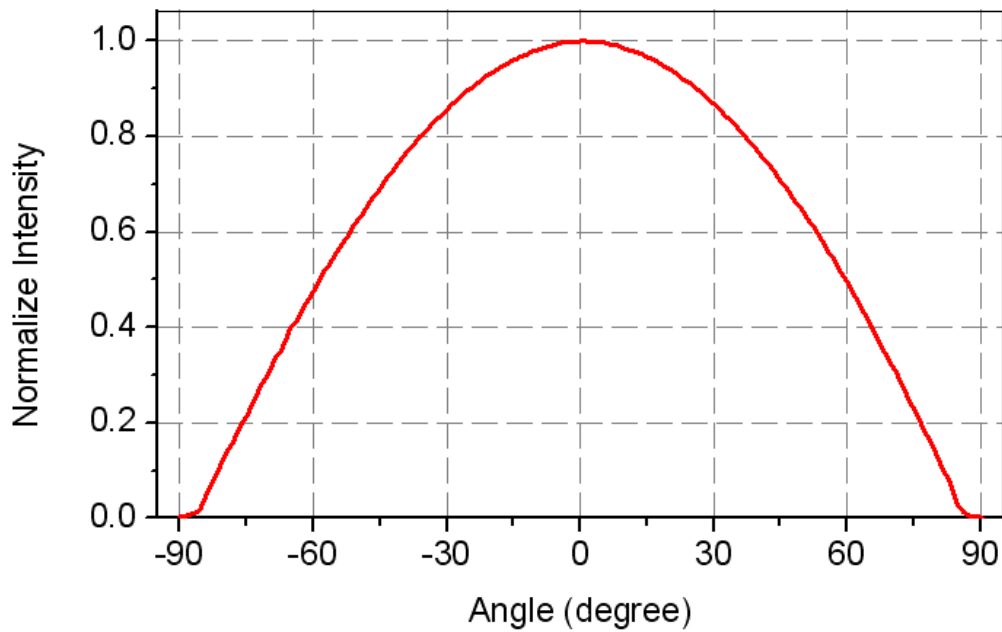

\* Note1 : Detail beam profile data can be provided to certain qualified customers

## LUSTRON X2<sup>NES</sup>

---

---

# LUSTROUS<sup>®</sup>

GREEN TECHNOLOGY OF LIGHTINGS

## Product Binning

Typical manufacturing processes of LED result in a variation in performance surrounding the typical data sheet values. In order to minimize variation in the end product of application, Lustrous bins its products for performance in luminous flux and chromaticity.

The tables below list the standard photometric bins for Lustrous LED ( tested and binned at the indicated test current ). **Product availability in a particular bin varies by product and production run. Please contact your Lustrous sales representative for further information regarding product availability.**

## Binning Condition

Table.6

Color	Forward Current (mA)
Warm White	
Neutral White	1050
Cool White	

LUSTRON X2<sup>NES</sup>

---

**LUSTROUS**<sup>®</sup>  
GREEN TECHNOLOGY OF LIGHTINGS

**Luminous Flux Binning Information \***

Table.7

BIN Code	Lv (lm)		BIN Code	Lv (lm)	
	min.	max.		min.	max.
A	5	20	L	320	360
B	20	40	M	360	400
C	40	60	N	400	450
D	60	80	O	450	500
E	80	110	P	500	580
F	110	140	Q	580	660
G	140	170	R	660	740
H	170	200	S	740	860
I	200	240	T	860	980
J	240	280	U	980	1100
K	280	320	V	1100	1300

\*Note: Luminous flux is measured in total power with tolerable errors of 10%.

**Chromaticity Binning Information \*\***

Warm White

**Warm White BIN Table**

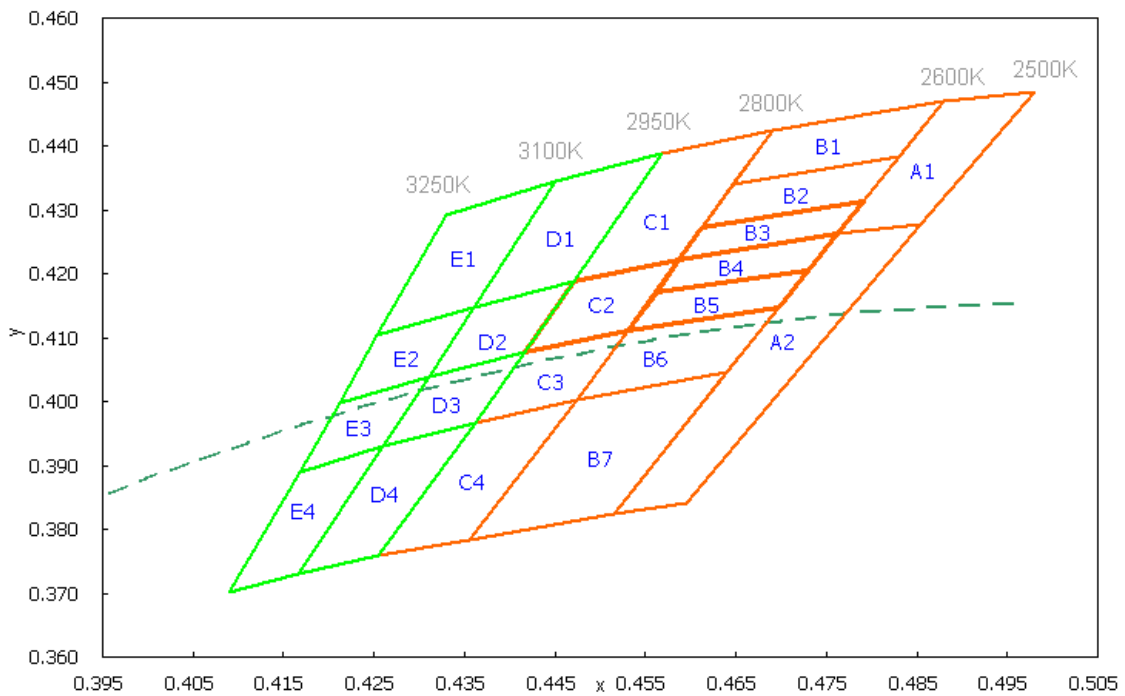

\*\*Note: Chromaticity is measured in Chromaticity Coordinate (CIE 1931-xy) with tolerable errors of +/-0.005.

**LUSTROUS**<sup>®</sup>  
GREEN TECHNOLOGY OF LIGHTINGS

**Table.8**

BIN Code	Chromaticity Coordinate (CIE 1931-xy)							
	x1	y1	x2	y2	x3	y3	x4	y4
A1	0.5002	0.4522	0.4901	0.4507	0.4762	0.4262	0.4854	0.4276
A2	0.4854	0.4276	0.4762	0.4262	0.4640	0.4045	0.4726	0.4060
A3	0.4726	0.4060	0.4640	0.4045	0.4478	0.3764	0.4561	0.3781
B1	0.4901	0.4507	0.4709	0.4463	0.4647	0.4340	0.4831	0.4383
B2	0.4831	0.4383	0.4647	0.4340	0.4613	0.4272	0.4791	0.4314
B3	0.4791	0.4314	0.4613	0.4272	0.4587	0.4222	0.4762	0.4262
B4	0.4762	0.4262	0.4587	0.4222	0.4563	0.4172	0.4730	0.4205
B5	0.4730	0.4205	0.4563	0.4172	0.4531	0.4110	0.4697	0.4147
B6	0.4697	0.4147	0.4531	0.4110	0.4474	0.4002	0.4640	0.4045
B7	0.4640	0.4045	0.4474	0.4002	0.4405	0.3873	0.4560	0.3908
B8	0.4560	0.3908	0.4405	0.3873	0.4328	0.3731	0.4478	0.3764
C1	0.4709	0.4463	0.4585	0.4425	0.4470	0.4187	0.4587	0.4222
C2	0.4587	0.4222	0.4470	0.4187	0.4417	0.4076	0.4531	0.4110
C3	0.4531	0.4110	0.4417	0.4076	0.4362	0.3967	0.4474	0.4002
C4	0.4474	0.4002	0.4362	0.3967	0.4300	0.3845	0.4405	0.3873
C5	0.4405	0.3873	0.4300	0.3845	0.4229	0.3706	0.4328	0.3731
D1	0.4585	0.4425	0.4466	0.4382	0.4360	0.4148	0.4470	0.4187
D2	0.4470	0.4187	0.4360	0.4148	0.4311	0.4039	0.4417	0.4076
D3	0.4417	0.4076	0.4311	0.4039	0.4260	0.3930	0.4362	0.3967
D4	0.4362	0.3967	0.4260	0.3930	0.4205	0.3813	0.4300	0.3845
D5	0.4300	0.3845	0.4205	0.3813	0.4142	0.3678	0.4229	0.3706
E1	0.4450	0.4345	0.4360	0.4148	0.4254	0.4103	0.4330	0.4293
E2	0.4360	0.4148	0.4311	0.4039	0.4211	0.3999	0.4254	0.4103
E3	0.4311	0.4039	0.4260	0.3930	0.4168	0.3890	0.4211	0.3999
E4	0.4260	0.3930	0.4167	0.3730	0.4090	0.3700	0.4168	0.3890

**LUSTRON X2<sup>NES</sup>**

Neutral White

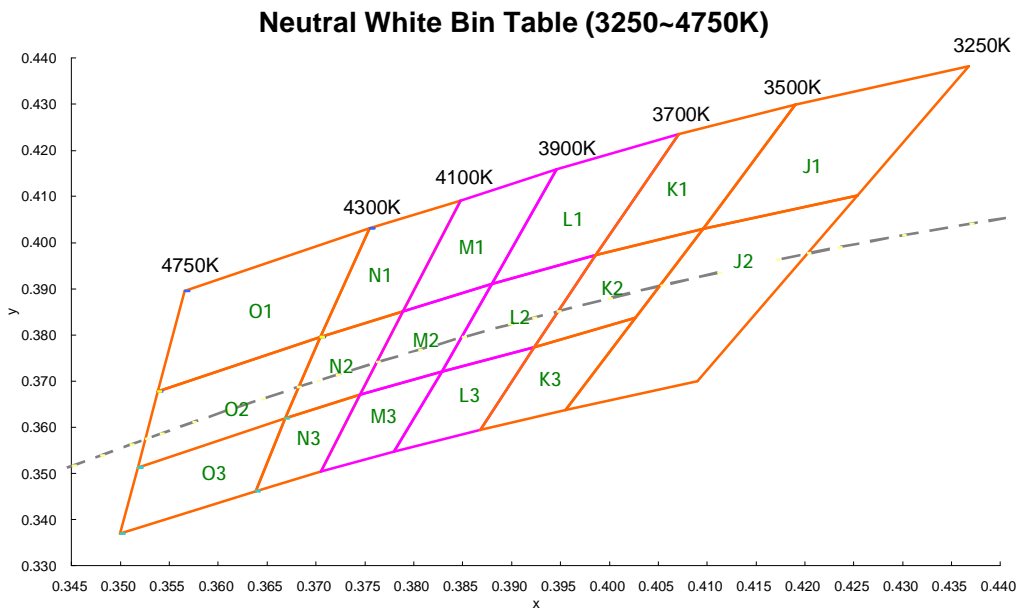

**LUSTROUS**<sup>®</sup>  
*GREEN TECHNOLOGY OF LIGHTINGS*

**Table.9**

BIN Code	Chromaticity Coordinate (CIE 1931-xy)							
	x1	y1	x2	y2	x3	y3	x4	y4
J1	0.4368	0.4382	0.4254	0.4103	0.4096	0.4030	0.4190	0.4299
J2	0.4254	0.4103	0.4090	0.3700	0.3955	0.3638	0.4096	0.4030
K1	0.4190	0.4299	0.4096	0.4030	0.3986	0.3973	0.4071	0.4235
K2	0.4096	0.4030	0.4026	0.3837	0.3923	0.3774	0.3986	0.3973
K3	0.4026	0.3837	0.3955	0.3638	0.3868	0.3595	0.3923	0.3774
L1	0.4071	0.4235	0.3986	0.3973	0.3880	0.3910	0.3946	0.4160
L2	0.3986	0.3973	0.3923	0.3774	0.3829	0.3721	0.3880	0.3910
L3	0.3923	0.3774	0.3868	0.3595	0.3780	0.3547	0.3829	0.3721
M1	0.3946	0.4160	0.3880	0.3910	0.3789	0.3851	0.3848	0.4091
M2	0.3880	0.3910	0.3829	0.3721	0.3745	0.3670	0.3789	0.3851
M3	0.3829	0.3721	0.3780	0.3547	0.3705	0.3505	0.3745	0.3670
N1	0.3848	0.4091	0.3789	0.3851	0.3705	0.3795	0.3755	0.4031
N2	0.3789	0.3851	0.3745	0.3670	0.3668	0.3620	0.3705	0.3795
N3	0.3745	0.3670	0.3705	0.3505	0.3638	0.3462	0.3668	0.3620
O1	0.3755	0.4031	0.3705	0.3795	0.3538	0.3677	0.3566	0.3895
O2	0.3705	0.3795	0.3668	0.3620	0.3518	0.3513	0.3538	0.3677
O3	0.3668	0.3620	0.3638	0.3462	0.3500	0.3369	0.3518	0.3513

**LUSTRON X2**<sup>NES</sup>

Cool White

**Cool White Bin Table (4750~10000K)**

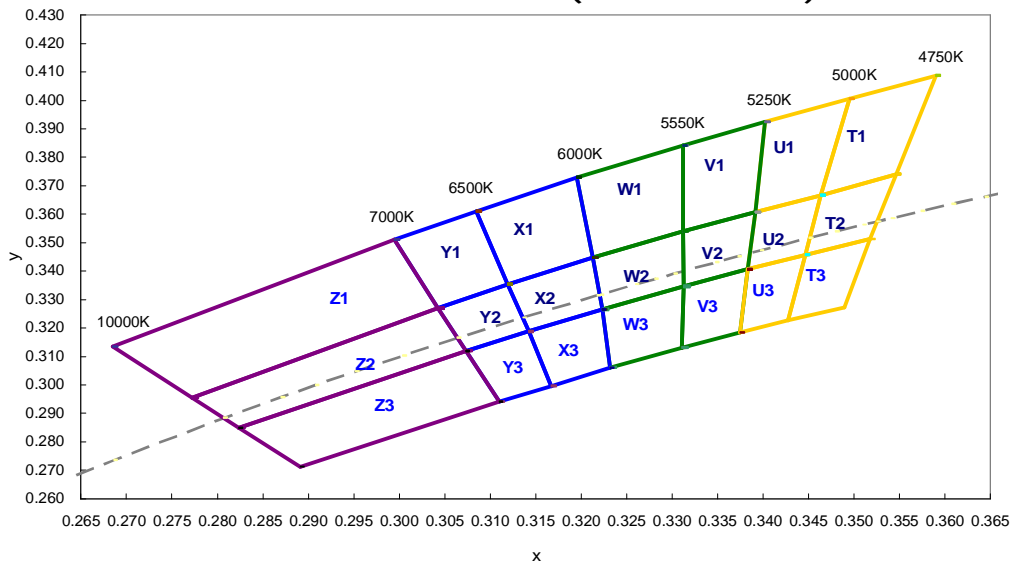

**LUSTROUS**<sup>®</sup>  
**GREEN TECHNOLOGY OF LIGHTINGS**

**Table.10**

BIN Code	Chromaticity Coordinate (CIE 1931-xy)							
	x1	y1	x2	y2	x3	y3	x4	y4
T1	0.3590	0.4088	0.3546	0.3741	0.3463	0.3667	0.3495	0.4005
T2	0.3546	0.3741	0.3518	0.3513	0.3446	0.3458	0.3463	0.3667
T3	0.3518	0.3513	0.3490	0.3272	0.3428	0.3227	0.3446	0.3458
U1	0.3495	0.4005	0.3463	0.3667	0.3392	0.3608	0.3403	0.3924
U2	0.3463	0.3667	0.3446	0.3458	0.3383	0.3406	0.3392	0.3608
U3	0.3446	0.3458	0.3428	0.3227	0.3374	0.3184	0.3383	0.3406
V1	0.3403	0.3924	0.3392	0.3608	0.3313	0.3540	0.3313	0.3841
V2	0.3392	0.3608	0.3383	0.3406	0.3313	0.3346	0.3313	0.3540
V3	0.3383	0.3406	0.3374	0.3184	0.3311	0.3132	0.3313	0.3346
W1	0.3313	0.3841	0.3312	0.3540	0.3213	0.3448	0.3195	0.3730
W2	0.3313	0.3540	0.3313	0.3346	0.3223	0.3266	0.3213	0.3448
W3	0.3313	0.3346	0.3311	0.3132	0.3232	0.3061	0.3223	0.3266
X1	0.3195	0.3730	0.3213	0.3448	0.3119	0.3354	0.3085	0.3610
X2	0.3213	0.3448	0.3223	0.3266	0.3142	0.3188	0.3119	0.3354
X3	0.3223	0.3266	0.3232	0.3061	0.3167	0.2997	0.3142	0.3188
Y1	0.3085	0.3610	0.3119	0.3354	0.3042	0.3270	0.2995	0.3510
Y2	0.3119	0.3354	0.3142	0.3188	0.3073	0.3120	0.3042	0.3270
Y3	0.3142	0.3188	0.3167	0.2997	0.3110	0.2941	0.3073	0.3120
Z1	0.2995	0.3510	0.3042	0.3270	0.2772	0.2955	0.2685	0.3135
Z2	0.3042	0.3270	0.3073	0.3120	0.2824	0.2850	0.2772	0.2955
Z3	0.3073	0.3120	0.3110	0.2941	0.2892	0.2713	0.2824	0.2850

**LUSTRON X2<sup>NES</sup>**

**Print Code Guideline**

N E S 1 1 0 C L C 0 B - X X X X X

1

2

X X X X X X X X X X X X X X

2

V 0 - O - B 2 - X X X X X X

3

4

5

6

7

8

Table.11

1 P/N	2 Internal Code	3 Vf	4 Luminous Flux
Warm White: NES110CLC0B Neutral White: NES110MWC0B Cool White: NES110NWC0B		V0: Without Binned	See Bin Code Definition

5 Chromaticity	6 Year	7 Month	8 Week
See Bin Code Definition	08: 2008 09: 2009 10: 2010	01 : January 05 : May 10 : October	01 : 01 <sup>st</sup> Week 20 : 20 <sup>th</sup> Week 45 : 45 <sup>th</sup> Week

**LUSTROUS**<sup>®</sup>  
GREEN TECHNOLOGY OF LIGHTINGS

**Standard Packaging**

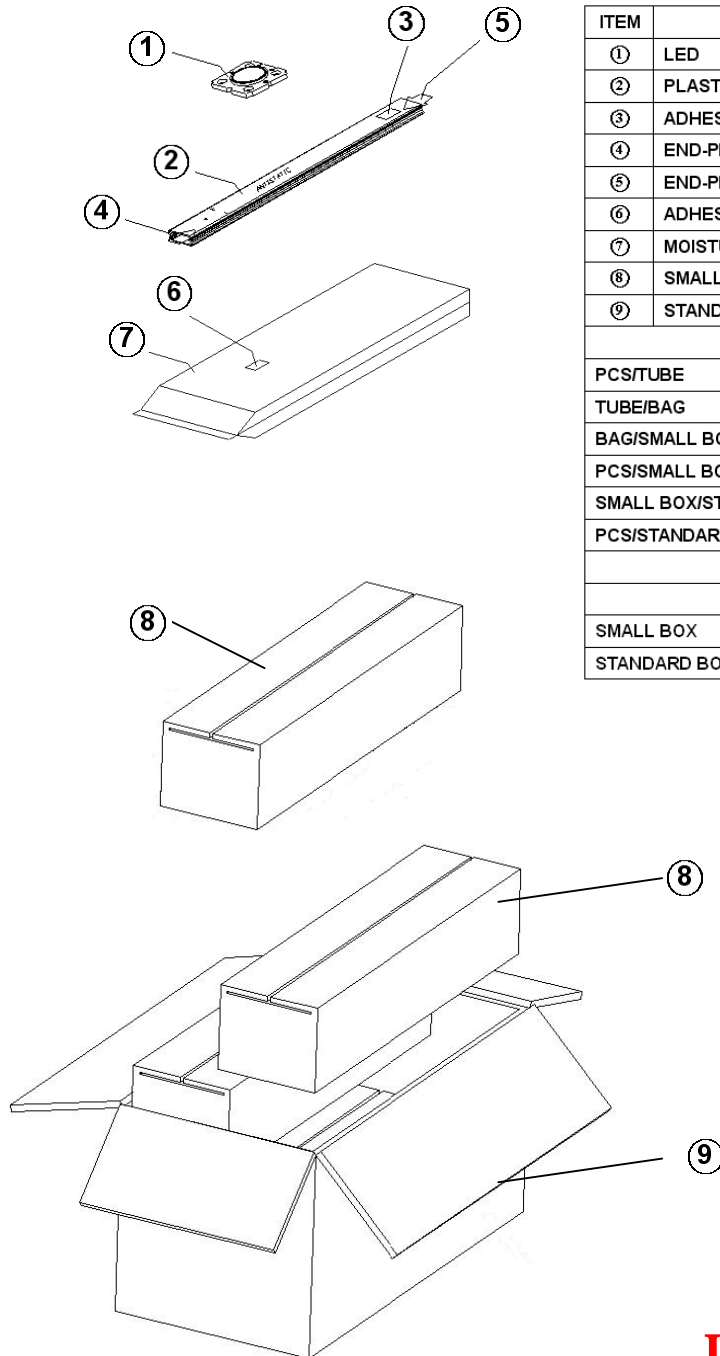

ITEM	DESCRIPTION	
①	LED	
②	PLASTIC TUBE	
③	ADHESIVE MAIN LABEL	
④	END-PLUG WHITE	
⑤	END-PLUG BLACK	
⑥	ADHESIVE MAIN LABEL	
⑦	MOISTURE BARRIER BAG	
⑧	SMALL BOX	
⑨	STANDARD BOX	
STACKING METHOD		
PCS/TUBE		10
TUBE/BAG		10
BAG/SMALL BOX		2
PCS/SMALL BOX		200
SMALL BOX/STANDARD BOX		4
PCS/STANDARD BOX		800
SIZE AND WEIGHT		
	SIZE(mm <sup>3</sup> )	WEIGHT(kg)
SMALL BOX	560×130×130	3.4±0.5
STANDARD BOX	580×280×280	14.3±0.5

**LUSTRON X2**<sup>NES</sup>

## Precaution for Use

### Over-current Proof

1. Customer must not drive the LEDs with reverse current and should apply resistors for extra protection.
2. The maximum overshoot of driving current should be limited under normal driving current \* 1.3 times.
3. The ripple of driving current should not be over +/-10% of normal driving current.
4. The typical driving current for this series is 1050 mA.
5. When driving the products, the clamp voltage must be set at 12V in driver.

### Storage

1. Do not open the moisture barrier bag (MBB) before the products are ready to be used.
2. Storage Condition (before opening the MBB) :
  - I Storage Temperature: -40~90°C
  - I Relative Humidity < 90% RH
  - I Please re-seal the MBB when storing longer than 3 weeks.
  - I The products should be used within half of a year.
3. Storage Condition (after opening the MBB) :
  - I Storage Temperature: -40~90°C
  - I Relative Humidity < 90% RH
  - I The products should be used (assembled) as soon as possible after opening the MBB. Otherwise, LED must be baked at 80+/-5°C, 24 hours before handling and assembling.

### Handling

1. Do not touch the lighting area during handling and assembling.

---

**LUSTROUS**<sup>®</sup>

GREEN TECHNOLOGY OF LIGHTINGS

## Company Information

Lustrous Technology, founded in 2004, endeavors to bring a new era of solid-state lighting. Our R&D development center and production facilities are based in Taiwan, a famous island for IT technology in the world. Our products are well designed in both performance and reliability. Lustrous is one of the leading high-power LED manufacturer and solution provider in the world.

\*\*Lustrous Technology may make process and material changes affecting performance and characteristics of our products without further notice. These products supplied after changes will continue to meet published specifications, but may not be identical to products supplied as samples or under prior orders.



**LUSTROUS TECHNOLOGY LTD**  
Green Technology of Lightings

Website: [www.LUSTROUS.com.tw](http://www.LUSTROUS.com.tw)  
Email: [sales@lustrous.com.tw](mailto:sales@lustrous.com.tw)  
Tel: +886-2-8647-2862  
Fax: +886-2-8647-2863  
Address: 5F, No 212-1, Sec.3, Datong Rd, Shiji City, Taipei County  
221, Taiwan

*All rights reserved. Product specifications are subject to change without further notice.*

**LUSTRON X2<sup>NES</sup>**

---